



Communication  
Networks  
course  
Physical Layer

Pr A.  
DJEFFAL

Physical Layer

Modes of  
transmission

Transmitted  
signal

Characteristics  
of a communi-  
cation  
line

Transmission  
media

Information  
coding

Multiplexing

# Communication Networks course Physical Layer

Pr A. DJEFFAL

2<sup>nd</sup> licence year

2025-2026

[www.abdelhamid-djeffal.net](http://www.abdelhamid-djeffal.net)



# Physical layer

## Physical Layer Role

Communication  
Networks  
course  
Physical Layer

Pr A.  
DJEFFAL

Physical Layer

Modes of  
transmission

Transmitted  
signal

Characteristics  
of a communi-  
cation  
line

Transmission  
media

Information  
coding

Multiplexing

- Transform a sequence of bits into signals (and vice versa)
- Determine how bits are transported on physical media.
- Introduce bits 0 and 1 on the medium in a specific form, recognizable by the receiver.



# Physical layer

## Used Components

Communication  
Networks  
course  
Physical Layer

Pr A.  
DJEFFAL

Physical Layer

Modes of  
transmission

Transmitted  
signal

Characteristics  
of a communi-  
cation  
line

Transmission  
media

Information  
coding

Multiplexing

- Cables, fibers, ...
- Sockets, connectors, ...
- Network Cards
- Repeaters, multiplexers, ...
- Modems, hubs, ...



# Physical layer

## Chapter Objective

Communication  
Networks  
course  
Physical Layer

Pr A.  
DJEFFAL

Physical Layer

Modes of  
transmission

Transmitted  
signal

Characteristics  
of a communi-  
cation  
line

Transmission  
media

Information  
coding

Multiplexing

- Study of transmission media and their characteristics,
- Study of the methods used for the transmission of information



# Modes of transmission

## Parallel transmission

Communication  
Networks  
course  
Physical Layer

Pr A.  
DJEFFAL

Physical Layer

Modes of  
transmission

Transmitted  
signal

Characteristics  
of a communi-  
cation  
line

Transmission  
media

Information  
coding

Multiplexing

Bits sent on separate wires

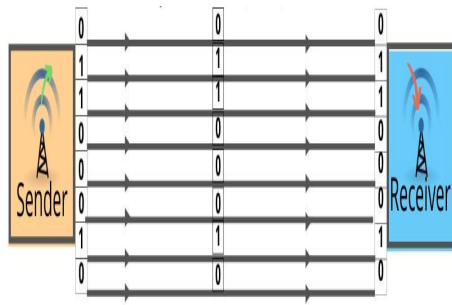

- Synchronization problems !!
- Suitable for short distances



# Modes of transmission

## Serial transmission

Communication  
Networks  
course  
Physical Layer

Pr A.  
DJEFFAL

Physical Layer

Modes of  
transmission

Transmitted  
signal

Characteristics  
of a communi-  
cation  
line

Transmission  
media

Information  
coding

Multiplexing

- Bits sent one after the other
- Used in computer networks
- Asynchronous or synchronous.

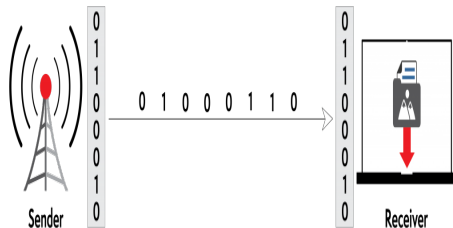



# Modes of transmission

## Asynchronous Serial Transmission

Communication  
Networks  
course  
Physical Layer

Pr A.  
DJEFFAL

Physical Layer

Modes of  
transmission

Transmitted  
signal

Characteristics  
of a communi-  
cation  
line

Transmission  
media

Information  
coding

Multiplexing

- Transmit Anytime
- Does not depend on specific time intervals
- START bit and STOP bit

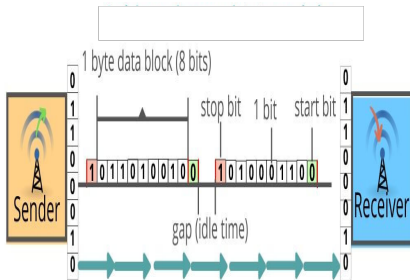



# Modes of transmission

## Synchronous Serial Transmission

Communication  
Networks  
course  
Physical Layer

Pr A.  
DJEFFAL

Physical Layer

Modes of  
transmission

Transmitted  
signal

Characteristics  
of a communi-  
cation  
line

Transmission  
media

Information  
coding

Multiplexing

- Convention on a constant elementary time interval
- Transmit at the beginning of the interval for a duration of one interval per information
- Broadband

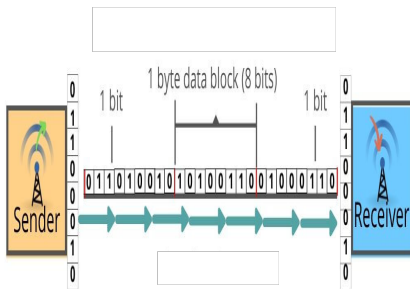



# Modes of transmission

## Simplex transmission

Communication  
Networks  
course  
Physical Layer

Pr A.  
DJEFFAL

Physical Layer

Modes of  
transmission

Transmitted  
signal

Characteristics  
of a communi-  
cation  
line

Transmission  
media

Information  
coding

Multiplexing

- One part is always sending and the other is always receiving
- Data always flows in the same direction

Simplex:





# Modes of transmission

## Half duplex transmission

Communication  
Networks  
course  
Physical Layer

Pr A.  
DJEFFAL

Physical Layer

Modes of  
transmission

Transmitted  
signal

Characteristics  
of a communi-  
cation  
line

Transmission  
media

Information  
coding

Multiplexing

- Channel operated on the alternator for the emission
- Transmitter and receiver transmit but not at the same time

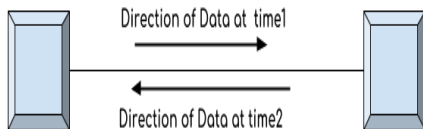



# Modes of transmission

## Full Duplex Transmission

Communication  
Networks  
course  
Physical Layer

Pr A.  
DJEFFAL

Physical Layer

Modes of  
transmission

Transmitted  
signal

Characteristics  
of a communi-  
cation  
line

Transmission  
media

Information  
coding

Multiplexing

- Full Duplex
- Bandwidth Sharing

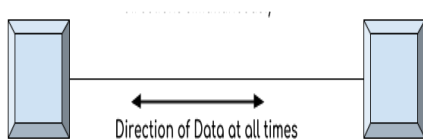



# Transmitted signal

## Signal

Communication  
Networks  
course  
Physical Layer

Pr A.  
DJEFFAL

Physical Layer

Modes of  
transmission

Transmitted  
signal

Characteristics  
of a communi-  
cation  
line

Transmission  
media

Information  
coding

Multiplexing

- Information Vehicle
- Propagation in the form of a wave resulting from the propagation of a vibratory phenomenon.
- 3 types of waves :
  - electric waves (cables, wires, ...),
  - radio waves (microwave, satellite),
  - light waves (fiber optics, infrared).



# Transmitted signal

Analog signal

Communication  
Networks  
course  
Physical Layer

Pr A.  
DJEFFAL

Physical Layer

Modes of  
transmission

Transmitted  
signal

Characteristics  
of a communi-  
cation  
line

Transmission  
media

Information  
coding

Multiplexing

- Continuous variation
- Levels of values proportional to the values of the information (sound, image)
- Long distances

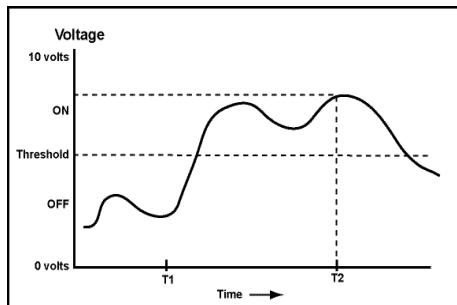



# Transmitted signal

## Digital signal

Communication  
Networks  
course  
Physical Layer

Pr A.  
DJEFFAL

Physical Layer

Modes of  
transmission

Transmitted  
signal

Characteristics  
of a communi-  
cation  
line

Transmission  
media

Information  
coding

Multiplexing

- Square shape
- Discontinuous variation
- Low number of fixed value levels
- Short distances

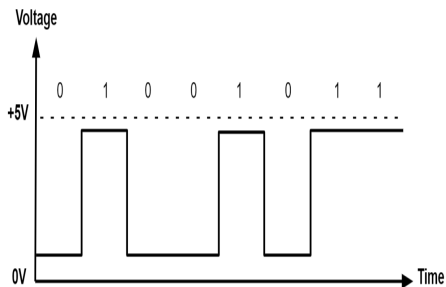



# Characteristics of a communication line

## Bandwidth

Communication Networks  
course  
Physical Layer

Pr A.  
DJEFFAL

Physical Layer

Modes of transmission

Transmitted signal

Characteristics of a communication line

Transmission media

Information coding

Multiplexing

The bandwidth of a channel is the frequency range over which the channel is able to transmit signals without their attenuation being too great.

$$W = f_{max} - f_{min}$$

$f_{min}$  : lower frequency ,  $f_{max}$  higher frequency

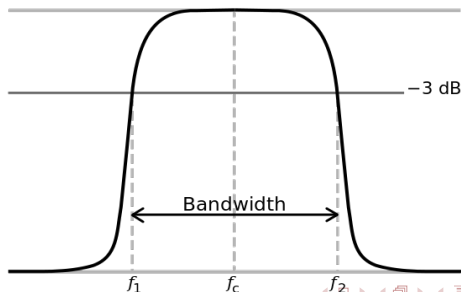



# Characteristics of a communication line

## $R$ modulation speed

Communication  
Networks  
course  
Physical Layer

Pr A.  
DJEFFAL

Physical Layer

Modes of  
transmission

Transmitted  
signal

Characteristics  
of a communi-  
cation  
line

Transmission  
media

Information  
coding

Multiplexing

Number of symbols transmitted per unit time

$$R = \frac{1}{\Delta} \text{ baud}$$

$\Delta$  duration of the interval separating two significant values

Nyquist criterion :

$$R_{max} = 2F_{max}$$



# Characteristics of a communication line

## Transmission Capacity $C$

Communication  
Networks  
course  
Physical Layer

Pr A.  
DJEFFAL

Physical Layer

Modes of  
transmission

Transmitted  
signal

Characteristics  
of a communi-  
cation  
line

Transmission  
media

Information  
coding

Multiplexing

$$C = 2W \text{ (bauds)}$$

Shannon (1949) :  $C$  depends on the Signal/Noise ratio

$$C = W \log_2 \left( 1 + \frac{S}{N} \right)$$

Often the Signal to Noise ratio is given in decibels such as :

$$(S/B)_{db} = 10 \log_{10} \left( \frac{S}{N} \right)$$



# Characteristics of a communication line

## Error rate

Communication  
Networks  
course  
Physical Layer

Pr A.  
DJEFFAL

Physical Layer

Modes of  
transmission

Transmitted  
signal

Characteristics  
of a communi-  
cation  
line

Transmission  
media

Information  
coding

Multiplexing

Probability of loss or alteration of information (1 bit). Example  
 $10^{-9}$



# Characteristics of a communication line

Bitrate  $D$

Communication  
Networks  
course  
Physical Layer

Pr A.  
DJEFFAL

Physical Layer

Modes of  
transmission

Transmitted  
signal

Characteristics  
of a communi-  
cation  
line

Transmission  
media

Information  
coding

Multiplexing

Number of bits transmitted per unit of time (512 Kbits/s, 1 Gigabit/s)

$$D = R \times \log_2(V)$$

$V$  valence of the signal : number of significant states

**Exercise** : If the duration of a bit is 20ms, what is the bit rate ?



# Characteristics of a communication line

Propagation delay  $T_p$

Communication  
Networks  
course  
Physical Layer

Pr A.  
DJEFFAL

Physical Layer

Modes of  
transmission

Transmitted  
signal

Characteristics  
of a communi-  
cation  
line

Transmission  
media

Information  
coding

Multiplexing

Time required for a signal to travel a medium from one point to another



# Transmission media

## Two Families

Communication  
Networks  
course  
Physical Layer

Pr A.  
DJEFFAL

Physical Layer

Modes of  
transmission

Transmitted  
signal

Characteristics  
of a communi-  
cation  
line

Transmission  
media

Information  
coding

Multiplexing

- Physical Guide Supports
  - Electric currents : twisted pairs, coaxial cables
  - Light : Fiber Optics
- Supports without physical guide
  - Electromagnetic Waves : Hertzian Beams, Radio Waves
  - Light : Laser, infrared



# Physical Guide Transmission Media

## Twisted Pairs (1)

Communication  
Networks  
course  
Physical Layer

Pr A.  
DJEFFAL

Physical Layer

Modes of  
transmission

Transmitted  
signal

Characteristics  
of a communi-  
cation  
line

Transmission  
media

Information  
coding

Multiplexing

RJ11 : telephone, RJ45 : computer networks

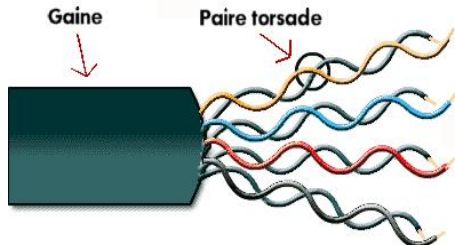



# Physical Guide Transmission Media

## Twisted Pairs (2)

Communication  
Networks  
course  
Physical Layer

Pr A.  
DJEFFAL

Physical Layer

Modes of  
transmission

Transmitted  
signal

Characteristics  
of a communi-  
cation  
line

Transmission  
media

Information  
coding

Multiplexing

### Connection : RJ45 connectors, RJ45 clip

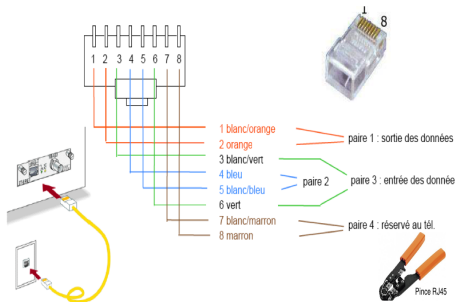



# Physical Guide Transmission Media

## Twisted Pairs (3)

Communication  
Networks  
course  
Physical Layer

Pr A.  
DJEFFAL

Physical Layer

Modes of  
transmission

Transmitted  
signal

Characteristics  
of a communi-  
cation  
line

Transmission  
media

Information  
coding

Multiplexing

### Disadvantages :

- Current Attenuation,
- Use of repeaters

### Benefits :

- Technique mastered,
- Ease of connection,
- Added new equipment,
- Low cost,
- Point-to-Point and Broadcast



# Physical Guide Transmission Media

## Twisted Pairs (4)

Communication  
Networks  
course  
Physical Layer

Pr A.  
DJEFFAL

Physical Layer

Modes of  
transmission

Transmitted  
signal

Characteristics  
of a communi-  
cation  
line

Transmission  
media

Information  
coding

Multiplexing

Types :

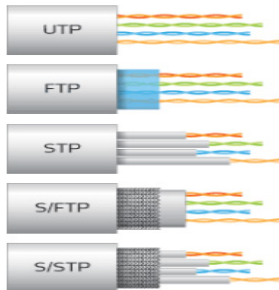



# Physical Guide Transmission Media

## Twisted Pairs (5)

Communication  
Networks  
course  
Physical Layer

Pr A.  
DJEFFAL

Physical Layer

Modes of  
transmission

Transmitted  
signal

Characteristics  
of a communi-  
cation  
line

Transmission  
media

Information  
coding

Multiplexing

### Catégories :

- Category 3 : 16MHz bandwidth, used for telephony.
- Category 5 : Bandwidth 100MHz, Speed 100MB/s over 100m used for telephony and networks
- Category 6 : Bandwidth 250MHz, Speed GB/s over 100m used for networks
- Category 6a : Bandwidth 500MHz, Speed 10GB/s over 100m
- Category 7 : Bandwidth 600Mhz, Throughput 10GB/send



# Physical Guide Transmission Media

## Coaxial cable (1)

Communication  
Networks  
course  
Physical Layer

Pr A.  
DJEFFAL

Physical Layer

Modes of  
transmission

Transmitted  
signal

Characteristics  
of a communi-  
cation  
line

Transmission  
media

Information  
coding

Multiplexing

Two cylindrical conductors on the same axis separated by an insulator, the whole being protected by a plastic sheath.

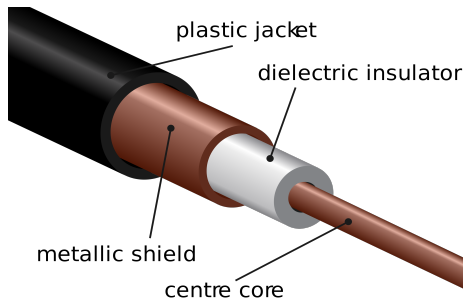



# Physical Guide Transmission Media

## Coaxial cable (2)

Communication  
Networks  
course  
Physical Layer

Pr A.  
DJEFFAL

Physical Layer

Modes of  
transmission

Transmitted  
signal

Characteristics  
of a communi-  
cation  
line

Transmission  
media

Information  
coding

Multiplexing

Kinds :

- Cable  $75\Omega$ , known as "broadband" (broadband) used for analog transmission : it's television cable !
- $50\Omega$  cable, called "baseband" (baseband) generally used to transmit digital signals. It allows a bandwidth of a few hundred MHz and speeds of up to 2Gbit/s.



# Physical Guide Transmission Media

## Coaxial cable (3)

Communication  
Networks  
course  
Physical Layer

Pr A.  
DJEFFAL

Physical Layer

Modes of  
transmission

Transmitted  
signal

Characteristics  
of a communi-  
cation  
line

Transmission  
media

Information  
coding

Multiplexing

Connection : vampire sockets for large cables and BNC plugs (British Naval Connector) for thin cables.

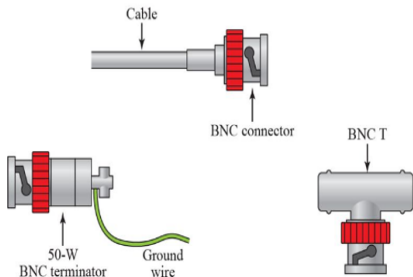

Disadvantage : a little expensive.



# Physical Guide Transmission Media

## Optical Fiber (Composition)

Communication  
Networks  
course  
Physical Layer

Pr A.  
DJEFFAL

Physical Layer

Modes of  
transmission

Transmitted  
signal

Characteristics  
of a communi-  
cation  
line

Transmission  
media

Information  
coding

Multiplexing

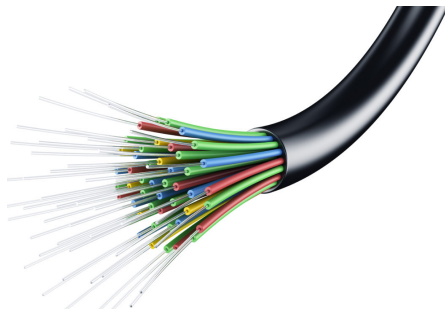



# Physical Guide Transmission Media

## Optical Fiber (Composition)

Communication  
Networks  
course  
Physical Layer

Pr A.  
DJEFFAL

Physical Layer

Modes of  
transmission

Transmitted  
signal

Characteristics  
of a communi-  
cation  
line

Transmission  
media

Information  
coding

Multiplexing





# Physical Guide Transmission Media

## Optical Fiber (Composition)

Communication  
Networks  
course  
Physical Layer

Pr A.  
DJEFFAL

Physical Layer

Modes of  
transmission

Transmitted  
signal

Characteristics  
of a communi-  
cation  
line

Transmission  
media

Information  
coding

Multiplexing

Consists of a core, in which the light emitted by a light-emitting diode or a laser source propagates, and an optical cladding whose refractive index ensures that the light signal remains in the fiber.

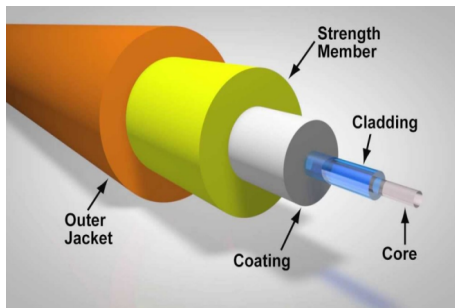



# Physical Guide Transmission Media

## Optical fiber (Principle)

Communication  
Networks  
course  
Physical Layer

Pr A.  
DJEFFAL

Physical Layer

Modes of  
transmission

Transmitted  
signal

Characteristics  
of a communi-  
cation  
line

Transmission  
media

Information  
coding

Multiplexing

Optical fiber transmission system :

- a light emitter (transmitter), consisting of a light emitting diode (LED, Light Emitting Diode) or a LASER diode (Light Amplification by Stimulated Emission of Radiation), which transforms electrical impulses into light impulses ;
- a light receiver, consisting of a PIN (Positive Intrinsic Negative) type photodiode which translates light pulses into electrical signals ;
- an optical fiber.



# Physical Guide Transmission Media

## Optical fiber (Principle)

Communication  
Networks  
course  
Physical Layer

Pr A.  
DJEFFAL

Physical Layer

Modes of  
transmission

Transmitted  
signal

Characteristics  
of a communi-  
cation  
line

Transmission  
media

Information  
coding

Multiplexing

Fiber optic transmission system :

Unidirectional system : 2 fibers for 1 connection.

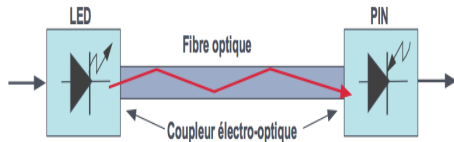

Fiber optic transmission system :

Unidirectional system : 2 fibers for 1 connection.



# Physical Guide Transmission Media

## Fiber Optics

Communication  
Networks  
course  
Physical Layer

Pr A.  
DJEFFAL

Physical Layer

Modes of  
transmission

Transmitted  
signal

Characteristics  
of a communi-  
cation  
line

Transmission  
media

Information  
coding

Multiplexing

## Single mode fiber

- Core diameter of  $8\mu m$ .
- For a given wavelength, the fiber only admits one ray.
- The fiber is then said to be monomode and the distance that can be covered is of the order of 100 km.



# Physical Guide Transmission Media

## Fiber Optics (Types)

Communication  
Networks  
course  
Physical Layer

Pr A.  
DJEFFAL

Physical Layer

Modes of  
transmission

Transmitted  
signal

Characteristics  
of a communi-  
cation  
line

Transmission  
media

Information  
coding

Multiplexing

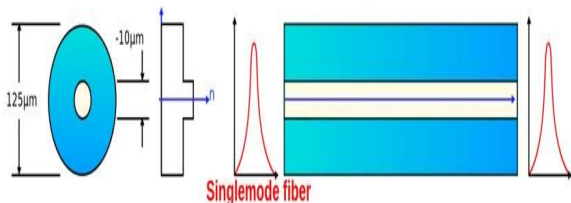



# Physical Guide Transmission Media

## Fiber Optics (Connectors)

Communication  
Networks  
course  
Physical Layer

Pr A.  
DJEFFAL

Physical Layer

Modes of  
transmission

Transmitted  
signal

Characteristics  
of a communi-  
cation  
line

Transmission  
media

Information  
coding

Multiplexing

Connection : SC (Subscriber Connector), ST (Straight Tip), FC (Fiber Connector), LC (Lucent Connector) connectors.



SC

LC

FC

ST



# Physical Guide Transmission Media

## Fiber Optics (Advantages)

Communication  
Networks  
course  
Physical Layer

Pr A.  
DJEFFAL

Physical Layer

Modes of  
transmission

Transmitted  
signal

Characteristics  
of a communi-  
cation  
line

Transmission  
media

Information  
coding

Multiplexing

Optical fiber Pt to Pt, but :

- Speeds up to 50 GBit/s (theoretical speed 50 TBit/s),
- Simultaneous transmission of many television channels, telephone,...
- Insensitive to electromagnetic interference,
- Outer diameter is around 0.1mm,
- Weight of a few grams per kilometre.
- Difficult to hack.



# Supports without physical guide

## Electromagnetic waves (1)

Communication  
Networks  
course  
Physical Layer

Pr A.  
DJEFFAL

Physical Layer

Modes of  
transmission

Transmitted  
signal

Characteristics  
of a communi-  
cation  
line

Transmission  
media

Information  
coding

Multiplexing

- Spread through the atmosphere,
- Flexibility of movement,
- No cable laying cost.

### Principle :

- Antenna radiates energy
- Collected by another antenna.

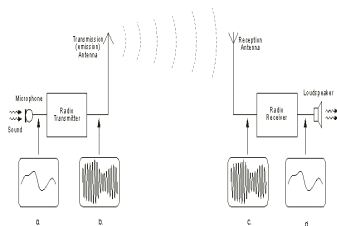

Fig. 2.1. Radio Transmission Block-Diagram



# Supports without physical guide

## Electromagnetic waves (2)

Communication  
Networks  
course  
Physical Layer

Pr A.  
DJEFFAL

Physical Layer

Modes of  
transmission

Transmitted  
signal

Characteristics  
of a communi-  
cation  
line

Transmission  
media

Information  
coding

Multiplexing

Each type of application  $\Rightarrow$  different frequency band  $\Rightarrow$   
Frequency space managed by national and international  
organizations.

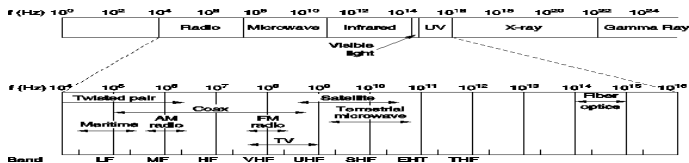

- High frequencies : long distances,
- low frequencies : geographically dispersed receivers.



# Supports without physical guide

## Electromagnetic waves (3)

Communication  
Networks  
course  
Physical Layer

Pr A.  
DJEFFAL

Physical Layer

Modes of  
transmission

Transmitted  
signal

Characteristics  
of a communi-  
cation  
line

Transmission  
media

Information  
coding

Multiplexing

Radio beam :

- Use of very high frequencies (from 2 GHz to 15 GHz and up to 40 GHz)
- Stations placed at height : direct visibility,
- Transmission by satellite, television channels or long-distance transmission arteries



# Supports without physical guide

## Electromagnetic waves (4)

Communication  
Networks  
course  
Physical Layer

Pr A.  
DJEFFAL

Physical Layer

Modes of  
transmission

Transmitted  
signal

Characteristics  
of a communi-  
cation  
line

Transmission  
media

Information  
coding

Multiplexing

Electric Radio waves () :

- Frequencies between 10 kHz and 2 GHz,
- Diffuse transmitter, geographically dispersed receivers,
- Interferences



# Supports without physical guide

## Light waves

Communication  
Networks  
course  
Physical Layer

Pr A.  
DJEFFAL

Physical Layer

Modes of  
transmission

Transmitted  
signal

Characteristics  
of a communi-  
cation  
line

Transmission  
media

Information  
coding

Multiplexing

- Infrared and lasers,
- Special case of microwave links, similar to fiber optics,
- Interconnect 2 private networks over a short distance,
- Speeds that can exceed 1 GBit/s

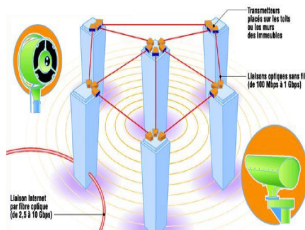



# Information coding

## Data circuit

Communication  
Networks  
course  
Physical Layer

Pr A.  
DJEFFAL

Physical Layer

Modes of  
transmission

Transmitted  
signal

Characteristics  
of a communi-  
cation  
line

Transmission  
media

Information  
coding

Multiplexing

- A device is placed at the ends to transmit the data,
- Manufacture and recovery of signals,
- Transparent to the user
- 2 Codecs (modems) + Transmission medium = Data circuit

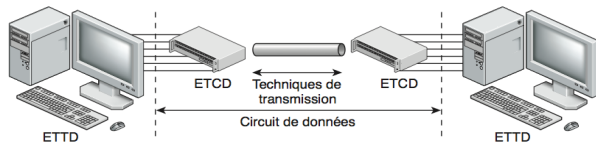



# Information coding

## Data circuit

Communication  
Networks  
course  
Physical Layer

Pr A.  
DJEFFAL

Physical Layer

Modes of  
transmission

Transmitted  
signal

Characteristics  
of a communi-  
cation  
line

Transmission  
media

Information  
coding

Multiplexing

- UTI standard designations
- Modem and codec DCTE (Data Circuit Termination Equipment)
- Computer TDPE (terminal data processing equipment)
- TDPE periodically sends 0s and 1s to the DCE
- DCTE converts to signal and sends **Synchronous message**

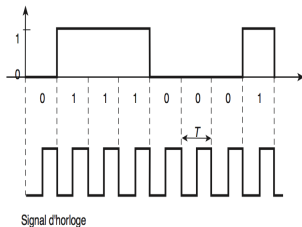



# Information coding

## Data circuit

Communication  
Networks  
course  
Physical Layer

Pr A.  
DJEFFAL

Physical Layer

Modes of  
transmission

Transmitted  
signal

Characteristics  
of a communi-  
cation  
line

Transmission  
media

Information  
coding

Multiplexing

- DCE converts to signal and sends **Synchronous message**,
- Equal intervals for all symbols,
- Matches transmitted clock,
- If short distance : digital transmission (in baseband)
- If long distance : Analog transmission (in transposed band or wideband)

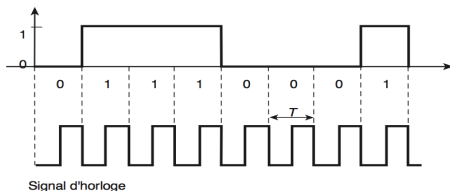



# Information coding

## Baseband transmission

Communication  
Networks  
course  
Physical Layer

Pr A.  
DJEFFAL

Physical Layer

Modes of  
transmission

Transmitted  
signal

Characteristics  
of a communi-  
cation  
line

Transmission  
media

Information  
coding

Multiplexing

- Digital signal (speed  $\uparrow + 1$  Mbit/s , range  $\downarrow$  A few hundred meters (LAN))
- Twisted Pairs, Coaxial Cable, Fiber
- Use of repeaters
- Long sequences 0 and 1 (rests)  $\Rightarrow$  Loss of synchronization
- Coding : introduce frequent state changes to avoid silences



# Information coding

## Baseband transmission

Communication  
Networks  
course  
Physical Layer

Pr A.  
DJEFFAL

Physical Layer

Modes of  
transmission

Transmitted  
signal

Characteristics  
of a communi-  
cation  
line

Transmission  
media

Information  
coding

Multiplexing

**Unipolar code** : The signal is transmitted without any change.

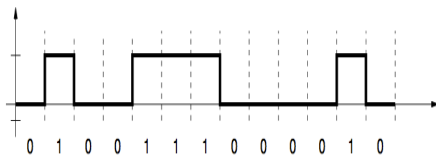

**Problem** : distinguish the case of 0 from the case of absence of information



# Information coding

## Baseband transmission

Communication  
Networks  
course  
Physical Layer

Pr A.  
DJEFFAL

Physical Layer

Modes of  
transmission

Transmitted  
signal

Characteristics  
of a communi-  
cation  
line

Transmission  
media

Information  
coding

Multiplexing

**NRZ code (No return to zero) :  $+a : 1$  ;  $-a : 0$**

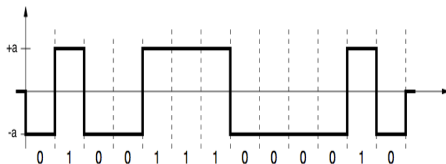

**Problem :** rests



# Information coding

## Baseband transmission

Communication  
Networks  
course  
Physical Layer

Pr A.  
DJEFFAL

Physical Layer

Modes of  
transmission

Transmitted  
signal

Characteristics  
of a communi-  
cation  
line

Transmission  
media

Information  
coding

Multiplexing

**NRZI code (No return to zero inverted) : same state : 1 ;  
change state : 0**

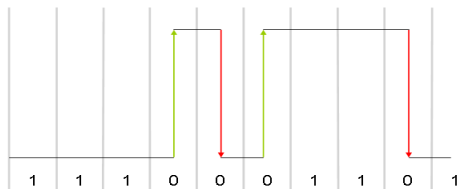



# Information coding

## Baseband transmission

Communication  
Networks  
course  
Physical Layer

Pr A.  
DJEFFAL

Physical Layer

Modes of  
transmission

Transmitted  
signal

Characteristics  
of a communi-  
cation  
line

Transmission  
media

Information  
coding

Multiplexing

**Manchester code (biphase) : XOR between clock and data (  $\uparrow$  : 0 ;  $\downarrow$  : 1 )**

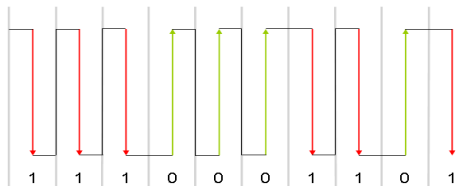



# Information coding

## Baseband transmission

Communication  
Networks  
course  
Physical Layer

Pr A.  
DJEFFAL

Physical Layer

Modes of  
transmission

Transmitted  
signal

Characteristics  
of a communi-  
cation  
line

Transmission  
media

Information  
coding

Multiplexing

## Differential Manchester code :

- systematic transition in the middle of each bit,
- at end of bit :
  - 1 : no transition,
  - 0 : transition

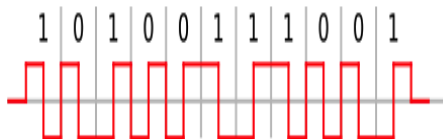



# Information coding

## Baseband transmission

Communication  
Networks  
course  
Physical Layer

Pr A.  
DJEFFAL

Physical Layer

Modes of  
transmission

Transmitted  
signal

Characteristics  
of a communi-  
cation  
line

Transmission  
media

Information  
coding

Multiplexing

### Miller code :

- 1 : mid-bit transition ;
- 0 : no transition in the middle of the bit ;
- transition at the end of a 0 bit if the next bit is 0

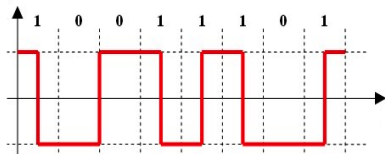



# Information coding

## Modulation (wideband)

Communication  
Networks  
course  
Physical Layer

Pr A.  
DJEFFAL

Physical Layer

Modes of  
transmission

Transmitted  
signal

Characteristics  
of a communi-  
cation  
line

Transmission  
media

Information  
coding

Multiplexing

- Distance + hundreds of meters  $\Rightarrow$  Unreliable baseband,
- The signal must be **modulated** : sine wave (carrier)
- Neither rising nor falling edges : greater range
- DCE : Modem (modulator-demodulator)



# Transmitted signal

## Signal

Communication  
Networks  
course  
Physical Layer

Pr A.  
DJEFFAL

Physical Layer

Modes of  
transmission

Transmitted  
signal

Characteristics  
of a communi-  
cation  
line

Transmission  
media

Information  
coding

Multiplexing

## Forme sinusoidale

$$y(t) = A \sin(2\pi ft + \varphi)$$

$A$  : amplitude,  $f$  : frequency,  $\varphi$  : phase.

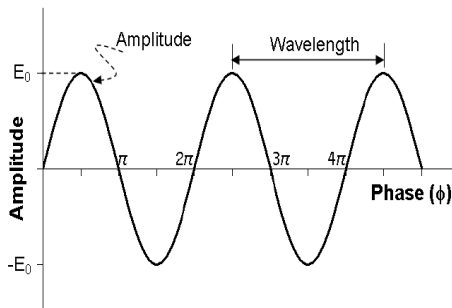



# Information coding

## Modulation (wideband)

Communication  
Networks  
course  
Physical Layer

Pr A.  
DJEFFAL

Physical Layer

Modes of  
transmission

Transmitted  
signal

Characteristics  
of a communi-  
cation  
line

Transmission  
media

Information  
coding

Multiplexing

Types of modulation :

- amplitude modulation, or ASK (Amplitude-Shift Keying) ;
- phase modulation, or PSK (Phase-Shift Keying) ;
- frequency modulation, or FSK (Frequency Shift Keying).
- Combined modulation.



# Information coding

## Amplitude Modulation

Communication  
Networks  
course  
Physical Layer

Pr A.  
DJEFFAL

Physical Layer

Modes of  
transmission

Transmitted  
signal

Characteristics  
of a communi-  
cation  
line

Transmission  
media

Information  
coding

Multiplexing

**ASK (Amplitude-Shift Keying) : change amplitude**

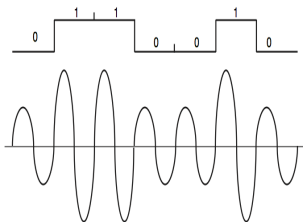



# Information coding

## Phase modulation

Communication  
Networks  
course  
Physical Layer

Pr A.  
DJEFFAL

Physical Layer

Modes of  
transmission

Transmitted  
signal

Characteristics  
of a communi-  
cation  
line

Transmission  
media

Information  
coding

Multiplexing

**PSK (Phase-Shift Keying)** : signal starts at different phases

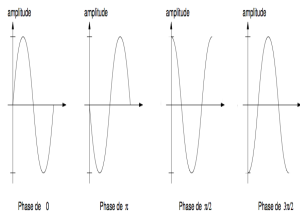



# Information coding

## Phase modulation

Communication  
Networks  
course  
Physical Layer

Pr A.  
DJEFFAL

Physical Layer

Modes of  
transmission

Transmitted  
signal

Characteristics  
of a communi-  
cation  
line

Transmission  
media

Information  
coding

Multiplexing

**PSK (Phase-Shift Keying) : signal starts at different phases**

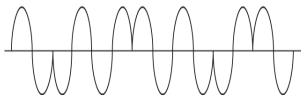
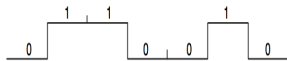



# Information coding

## Frequency modulation

Communication  
Networks  
course  
Physical Layer

Pr A.  
DJEFFAL

Physical Layer

Modes of  
transmission

Transmitted  
signal

Characteristics  
of a communi-  
cation  
line

Transmission  
media

Information  
coding

Multiplexing

**FSK (Frequency Shift Keying) : change the frequency**

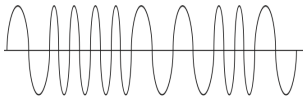
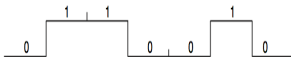



# Information coding

## Combined modulation

Communication  
Networks  
course  
Physical Layer

Pr A.  
DJEFFAL

Physical Layer

Modes of  
transmission

Transmitted  
signal

Characteristics  
of a communi-  
cation  
line

Transmission  
media

Information  
coding

Multiplexing

**Phase and amplitude modulation (PSK + AM) : combine phase and amplitude**

- 00 : phase of  $\pi$  and amplitude of 3
- 01 : phase of  $\pi$  and amplitude of 6
- 10 : phase of 0 and amplitude of 3
- 11 : phase of 0 and amplitude of 6



# Information coding

## Combined modulation

Communication  
Networks  
course  
Physical Layer

Pr A.  
DJEFFAL

Physical Layer

Modes of  
transmission

Transmitted  
signal

Characteristics  
of a communi-  
cation  
line

Transmission  
media

Information  
coding

Multiplexing

**Modulation by phase amplitude (PSK + AM) : combine  
phase and amplitude**

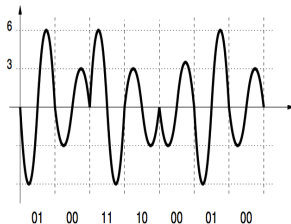



# Information coding

## Combined modulation

Communication  
Networks  
course  
Physical Layer

Pr A.  
DJEFFAL

Physical Layer

Modes of  
transmission

Transmitted  
signal

Characteristics  
of a communi-  
cation  
line

Transmission  
media

Information  
coding

Multiplexing

**Phase and amplitude modulation (PSK + AM) :**  
quadrature carrier amplitude modulation (QAM, or QAM  
Quadrature Amplitude Modulation)

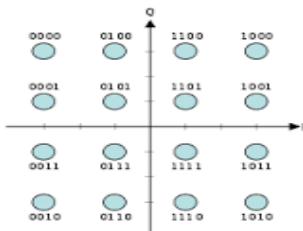



# Information coding

## Combined modulation

Communication  
Networks  
course  
Physical Layer

Pr A.  
DJEFFAL

Physical Layer

Modes of  
transmission

Transmitted  
signal

Characteristics  
of a communi-  
cation  
line

Transmission  
media

Information  
coding

Multiplexing

## Trellis

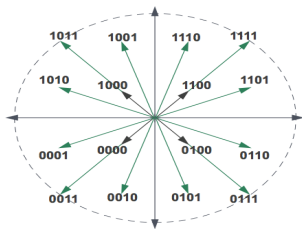

- High throughputs,
- Resistance to errors by Gray coding (2 adjacent codes  $\Rightarrow$  1 different bit)



# Information coding

## Modems

Communication  
Networks  
course  
Physical Layer

Pr A.  
DJEFFAL

Physical Layer

Modes of  
transmission

Transmitted  
signal

Characteristics  
of a communi-  
cation  
line

Transmission  
media

Information  
coding

Multiplexing

## Types of modems :

- Dial-up Modems

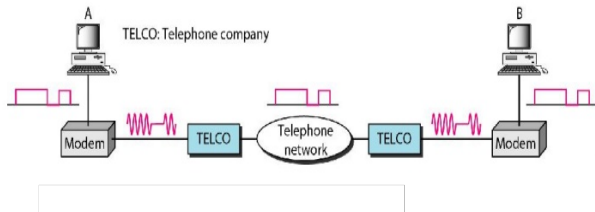



# Information coding

## Modems

Communication  
Networks  
course  
Physical Layer

Pr A.  
DJEFFAL

Physical Layer

Modes of  
transmission

Transmitted  
signal

Characteristics  
of a communi-  
cation  
line

Transmission  
media

Information  
coding

Multiplexing

## Types of modems :

- DSL (Digital Subscriber Line) Modems

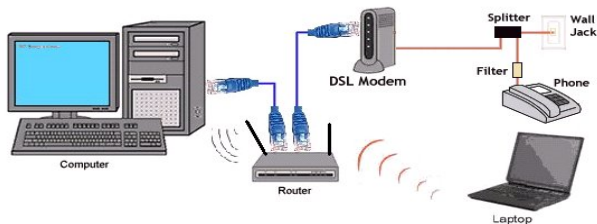



# Information coding

## Modems

Communication  
Networks  
course  
Physical Layer

Pr A.  
DJEFFAL

Physical Layer

Modes of  
transmission

Transmitted  
signal

Characteristics  
of a communi-  
cation  
line

Transmission  
media

Information  
coding

Multiplexing

## Types of modems :

- Cable Modems

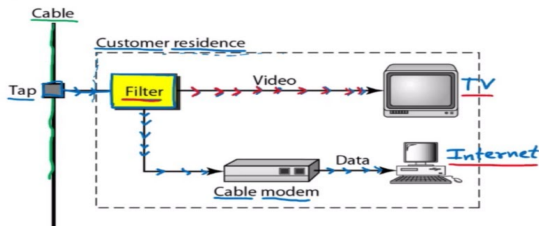



# Information coding

## Modems

Communication  
Networks  
course  
Physical Layer

Pr A.  
DJEFFAL

Physical Layer

Modes of  
transmission

Transmitted  
signal

Characteristics  
of a communi-  
cation  
line

Transmission  
media

Information  
coding

Multiplexing

### Types of modems :

- Fiber Optic Modems





# Information coding

## Modems

Communication  
Networks  
course  
Physical Layer

Pr A.  
DJEFFAL

Physical Layer

Modes of  
transmission

Transmitted  
signal

Characteristics  
of a communi-  
cation  
line

Transmission  
media

Information  
coding

Multiplexing

### Types of modems :

- Wireless Modems





### ADSL transmission :

- RTC : limited bandwidth, poor signal-to-noise ratio  $\Rightarrow$  throughput tens of kbit/s
- Asymmetric Digital Subscriber Line : several Mbit/s over 5 km
- Voice and data simultaneously
- $\neq$  frequency bands : 1.1 MHz band subdivided into 4KHZ channels
- Upstream : 640 kbit/s & Downstream : 2 Mbit/s



# Information coding

## ADSL Transmission

Communication  
Networks  
course  
Physical Layer

Pr A.  
DJEFFAL

Physical Layer

Modes of  
transmission

Transmitted  
signal

Characteristics  
of a communi-  
cation  
line

Transmission  
media

Information  
coding

Multiplexing

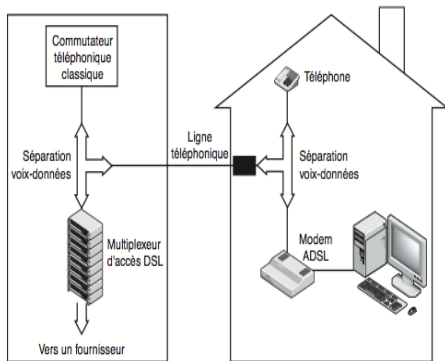

Speed can reach 20 Mbits/s with versions such as ADSL2 and ADSL2+



# Information coding

## Modems

Communication  
Networks  
course  
Physical Layer

Pr A.  
DJEFFAL

Physical Layer

Modes of  
transmission

Transmitted  
signal

Characteristics  
of a communi-  
cation  
line

Transmission  
media

Information  
coding

Multiplexing

**Standardized modems :** ITU has set the standards for modems

standard	modulation	rate
V.21	frequency	300 bit/s
V.26	phase	2400 bps
V.32	phase/amplitude	9600 bit/s
V.32bis	phase/amplitude	14 400 bit/s
V.34	phase/amplitude	28,800 bit/s
V.34bis	phase/amplitude	33 600 bit/s
V.90	phase/amplitude	56,000 bit/s



# Multiplexing

## Principle

Communication  
Networks  
course  
Physical Layer

Pr A.  
DJEFFAL

Physical Layer

Modes of  
transmission

Transmitted  
signal

Characteristics  
of a communi-  
cation  
line

Transmission  
media

Information  
coding

Multiplexing

- Transmit on a single link (high speed), communications from several transmitters and receivers
- Multiplexer - Demultiplexer



# Multiplexing

## Time Division Multiplexing Access (TDMA) Time Multiplexing

Communication  
Networks  
course  
Physical Layer

Pr A.  
DJEFFAL

Physical Layer

Modes of  
transmission

Transmitted  
signal

Characteristics  
of a communi-  
cation  
line

Transmission  
media

Information  
coding

Multiplexing

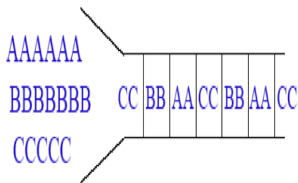



# Multiplexing

## Frequency Division Multiplexing (FDM)

Communication  
Networks  
course  
Physical Layer

Pr A.  
DJEFFAL

Physical Layer

Modes of  
transmission

Transmitted  
signal

Characteristics  
of a communi-  
cation  
line

Transmission  
media

Information  
coding

Multiplexing

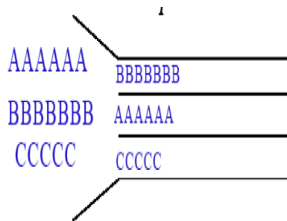



# Multiplexing

## Asynchronous Time Division Multiplexing (ATDM) Statistical Multiplexing

Communication  
Networks  
course  
Physical Layer

Pr A.  
DJEFFAL

Physical Layer

Modes of  
transmission

Transmitted  
signal

Characteristics  
of a communi-  
cation  
line

Transmission  
media

Information  
coding

Multiplexing

- assign high speed channel only to low speed channels that actually have something to transmit
- not bass rests